



Installation, Operating and Maintenance Instructions

Electric Chain Hoist

29/06E

Ultra-low headroom configuration

as monorail push travel trolley

ER

as monorail hand geared trolley

EH

as monorail electric trolley

EE

with monorail trolley Big Bag

EHL and EEL

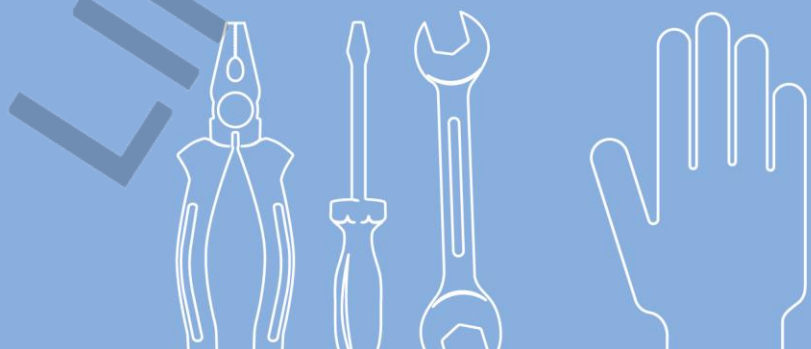
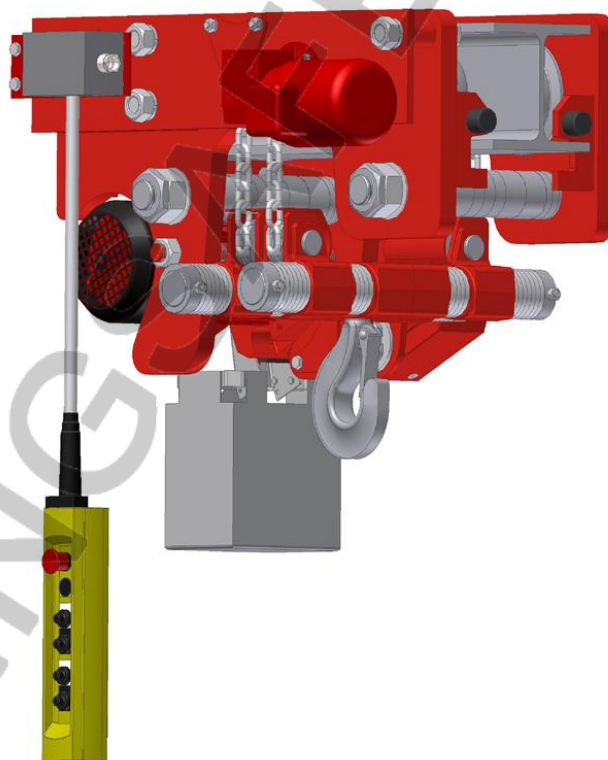

NOTICE!

The installation or mounting instructions for incomplete machines you'll find in chapter "Installation".

© by Heinrich de Fries GmbH

Heinrich de Fries GmbH, Gauss Str. 20, D-40235 Düsseldorf

Heinrich De Fries GmbH will be named HADEF in the following text.

Original operating- and maintenance instructions in German language.

Translation in other languages is made of the German original.

A copy may be requested in writing or is available for download on www.hadef.com

Subject to changes.

Table of Contents

1	Information	3
1.1	Indications to determine the used part of the theoretical usage life.....	4
2	Safety	4
2.1	Warning notice and symbols.....	4
2.2	Duty of care of the owner.....	4
2.3	Requirements for the operating personnel	5
2.4	Appropriate use	5
2.5	Basic safety measures	6
3	Transport and Storage	7
3.1	Transport.....	7
3.2	Safety device for transport	7
3.3	Storage	7
4	Description	7
4.1	Areas of application	7
4.2	Design.....	8
4.3	Functions.....	8
4.4	Important components.....	8
4.5	2nd brake (optional)	10
5	Technical data.....	10
6	Installation.....	11
6.1	Trolley.....	11
6.2	Devices with a load capacity of up to 6,3 t.....	12
6.3	Devices from 8 t up to 60 t capacity.....	13
6.4	Chain container installation.....	13
6.5	Pedant control installation.....	14
6.6	Tools	15
7	Control	15
8	Operation.....	17
9	Commissioning.....	17
9.1	General	17
9.2	Power supply	18
9.3	Gear.....	19
9.4	Load chain.....	19
9.5	Power operated hoists with chain container:	19
10	Safety check.....	19

11	Functional test	19
11.1	Checks before the initial start-up.....	19
11.2	Functional test.....	20
12	Maintenance	20
12.1	General.....	20
12.2	Monitoring.....	20
12.3	Replacing the load chain.....	20
12.4	Brake motor.....	21
12.5	Overload protection.....	21
12.6	Stretch the roller chain.....	22
13	Inspection	23
13.1	General Overhaul for motor-driven units.....	23
13.2	Periodic checks.....	23
13.3	Checking the load chain.....	24
13.4	Checking the load hook.....	24
13.5	Inspection – Gear – Oil level.....	25
14	Service	25
14.1	Load chain.....	25
14.2	Pulleys.....	25
14.3	Load hook.....	25
14.4	Hoist gear.....	26
14.5	Trolley.....	26
14.6	Tension device.....	27
14.7	Electric motor.....	27
14.8	Lubricant selection.....	27
14.9	Lubricant for food industry – selection (as option*).....	27
15	Trouble	27
16	Remedy	28
17	Decommissioning	28
17.1	Temporary decommissioning.....	29
17.2	Final decommissioning/disposal.....	29
18	Additional documents	29
18.1	Electric wiring diagrams.....	29
18.2	Radio control (as option).....	29

1 Information

The products meet European Union requirements, in particular the validated EU Machine Directive.

The entire company works acc. to a certified quality assurance system as per ISO 9001.

The production of components at our work is subject to strict, intermediate checks.

After assembly, each product is subject to a final test with overload.

For the operation of hoists, the national accident prevention regulations apply in Germany, amongst others.

The stated performance of the devices and meeting any warranty claims require adherence to all instructions in this manual.

Before delivery, all products are packed properly. Check the goods after receipt for any damage caused during transport. Report any damage immediately to the forwarding agent.

This manual allows a safe and efficiently use of equipment. Images of this manual are for a principle understanding and can be different from the real design.

 **NOTICE!**

We refer to the prescribed equipment tests before initial start-up, before putting back into operation and the regular periodic inspections.
In other countries any additional national regulations must be observed.

1.1 Indications to determine the used part of the theoretical usage life.

For motor driven units.

The equipment (rope hoists, chain hoists, winches as well as crane hoisting units) are classified in drive groups (duty classification) according to their intended mode of operation, running times and load collectives and dimensioned according to the requirements derived from these.

They are thus only designed for a limited period of use with regard to the overall dimensioning and certification.

After the total period of use as elapsed, measures must be taken where parts are checked and exchanged as per indication by the manufacturer. After that a new maximum usage period is determined. See also the valued accident prevention regulations, "winches, lifting and pulling devices".

 **NOTICE!**





Commitment



A general overhaul may only be performed by HADEF or by a specialized company, authorized by HADEF!

2 Safety

2.1 Warning notice and symbols

Warnings and notice are shown as follows in these instructions:

 DANGER!	This means that there is a high risk that leads, if it is not avoided, to death or severe injury.
 WARNING!	This means that there is a risk that could lead, if it is not avoided, to death or severe injury.
 CAUTION!	This means that there is little risk that could lead, if it is not avoided, to slight injury or damage to the device or its surrounding.
 NOTICE!	Gives advice for use and other useful information.

	Danger from electricity.
	Danger from explosive area.

2.2 Duty of care of the owner

 DANGER!
Failure to follow the instructions of this manual can lead to unpredictable hazards. For any resulting damage or personal injury, HADEF assumes no liability.

The unit was designed and built following a risk analysis and careful selection of the harmonized standards that are to be complied with, as well as other technical specifications. It therefore represents state-of-the-art technology and provides the highest degree of safety.

Our delivery includes the hoist supplied beginning at its suspension and ending at the load hook and if supplied with control, the control line/hose that leads to the hoist. Further operating material, tools, load attaching devices as well as main energy supply lines must be assembled according to the valid rules and regulations. For explosion-proof equipment, all these parts must be approved for use in area prone to explosion, or they must be suitable for use in area prone to explosion. The owner is responsible for this.

However, in everyday operation this degree of safety can only be achieved if all measures required are taken. It falls within the duty of care of the owner/user of the devices to plan these measures and to check that they are being complied with.

Complete the operating and installation instructions by any instructions (regarding supervision or notifications) that are important for the special kind of use of the equipment, i.e. regarding organization of work, work flow and human resources.

In particular, the owner/user must ensure that:

- The unit is only used appropriately.
- The device is only operated in a fault-free, fully functional condition, and the safety components, in particular, are checked regularly to ensure that it is functioning properly.
- The required personal protective equipment for the operators, service and repair personnel is available and is used.
- The operating instructions are always available at the location where the equipment is used and that they are legible and complete.
- The unit is only operated, serviced and repaired by qualified and authorized personnel.
- This personnel is regularly trained in all applicable matters regarding safety at work and environmental protection, and that they are familiar with the operating manual and, in particular, the safety instructions it contains.
- Any safety and warning signs on the devices are not removed and remain legible.
- customers equipment at site must comply with currently applicable ATEX-regulations

WARNING!

It is not allowed to make constructive changes of the equipment!

2.3 Requirements for the operating personnel

The units may only be operated by qualified persons that are appropriately trained and that are familiar with it. They must have their employer's authorization for operation of the units.

Before starting work, the operating personnel must have read the operating and installation instructions, especially the chapter "Safety Instructions".

This is especially important for operating personnel that rarely uses the equipment, i.e. for installation or maintenance work.

DANGER!

In order to avoid severe injury, please pay attention to the following when using the equipment:

- Use protective clothes/equipment.
- Do not wear long hair hanging down open.
- Do not wear rings or other jewelry.
- Do not wear clothes that are too big/wide.
- Do not reach into ropes, chains, drive parts or other moving parts with your hands

2.4 Appropriate use

The appropriate use of the hoists is vertical lifting and lowering of unguided loads up to the maximum rated load. In combination with trolleys, loads can also be moved horizontally.

The permitted safe working load of the devices must not be exceeded! An exception can be made during the load test before initial operation, carried out by a licensed qualified person.

- Defective devices and load suspension devices must not be used until they have been repaired! Only original spare parts must be used. Non-compliance will result in any warranty claims becoming void.
- Liability and warranty will become void if unauthorized modifications of the units are made by the user!
- The permissible ambient temperature when operating the devices:

Type of drive	Device classification for	
	not explosive atmosphere	Explosive atmosphere according to  ATEX ⁾ ^{**}
Manually driven	-20°C/+50°C	-20°C/+40°C
Motor driven	-20°C/+40°C	-20°C/+40°C

) * At an atmospheric pressure range from 0.8bar to 1.1bar and an oxygen content of approx. 21%

) ** Devices of this category have been specially modified and labeled by the manufacturer

⚠ DANGER!

The ambient temperature range must not be exceeded!

👉 NOTICE!

If the units are not used as intended, safe operation is not guaranteed.

The operator alone is responsible for all personal injury and damage to property resulting from improper use.

2.5 Basic safety measures

- Observe installation-, operation and maintenance instruction.
- Take notice of caution notes at units and in the manual
- Observe safety distances.
- Ensure good visibility during operations
- Use the equipment only for its intended purpose
- The equipment is only intended for moving goods. Persons must not be moved under any circumstances.
- Never load the equipment beyond the specified permissible load capacity.
- Observe the relevant national accident prevention regulations.
- Should the hoist be used outside of Germany, please pay attention to the national regulations that apply.
- Building walls, ceilings, floors or constructions - on which the units are mounted or suspended - must be checked by a structural engineer for sufficient stability.
- After the unit has been standing for a longer period of time, visually inspect all components that are important for its function and replace damaged components with new original spare parts.
- Do not use a defective unit; listen for abnormal operating noises.
- In case of malfunctions, stop the operation immediately and rectify the fault.
- Report damage and defects immediately to a responsible person
- When working with the unit, warn persons in the immediate vicinity.
- Observe the provisions for load suspension equipment in accordance with the relevant national regulations for the positive and non-positive slinging of loads.
- The sling or load must be securely attached to the load hook and rest on the bottom of the hook.
- The safety latches of hooks must be closed.
- The housing must not be in contact with anything.
- Stop lowering the load when the bottom block or the load is being set down or is prevented from being lowered further.
- The loose chain end may not be charged or locked.
- The load chain must not be twisted.
- Twisted chains must be aligned before attaching the load.
- The correct alignment of the chain links can be seen from the weld seams.
- The chain links must always be aligned in one direction.
- Do not bounce the load or hook against something.
- Check brakes daily before commencing work.
- The devices are not suitable for continuous operation. The duty cycles of the motors (see the technical data chapter) as well as the remaining life time of the equipment in accordance with FEM group and usage (see calculation of remaining safe working period) must be observed.

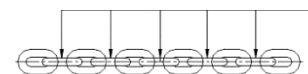

Illustration 1

⚠ WARNING!

The following is not allowed:

- to lift another load than the nominal safe working load
- to manipulate the sliding clutch if units are equipped with
- The use of elongated or damaged chains or wire ropes. Replace them immediately by new, original parts.
- Never loop the load chain around a load nor place or pull the chain over edges.
- Never repair damaged load hooks (e.g. by hammering), but replace them by original hooks.

3 Transport and Storage

CAUTION!

Transport may only be done by qualified personnel. No liability for any damage resulting from improper transport or improper storage.

3.1 Transport

The devices are checked and if so adequately packed before delivery.

- Do not throw or drop the equipment.
- Use adequate means of transport.

Transport and means of transport must be suitable for the local conditions.

3.2 Safety device for transport

NOTICE!

Should a safety device for transport exist, please remove it before commissioning.

3.3 Storage

- Store the equipment at a clean and dry place.
- Protect the equipment against dirt, humidity and damage by an appropriate cover.
- Protect hooks, wire ropes, chains and brakes against corrosion.

DANGER!

Units that show corrosion must be taken out of service!

4 Description

4.1 Areas of application

The devices must be as far as possible installed in a covered room.

If they are used in the open, protect the units against the effects of weather such as rain, hail, snow, direct sunshine, dust, etc. - we recommend to use a cover in parking position. If the device is set up in a continuously humid environment with strong temperature fluctuations, the correct functionings are endangered by the forming of condensation.

During longer downtimes of motor-operated units, the brake may reduce the function by corrosion.

NOTICE!

Use only in the intended atmosphere with a humidity of up to 100%, but not under water!

DANGER!

In particular, use is not permitted:

- for tearing loose fixed loads, dragging of loads as well as diagonal pulling
- for pulling against a fixed point without additional safety and/or measuring equipment against exceeding the nominal load
- in potentially explosive atmospheres, unless the equipment has been modified for this purpose and this is shown on special type plates it carries for this purpose.
- in reactor containments
- for transporting persons
- for holding lifted loads
- for scenic use
- when persons are under suspended loads

4.2 Design

HADEF electric chain hoists, with ultralow headroom are monorail trolleys with integrated hoist.

Drive:

Hoist is driven by electric motor.

Trolleys are operated by hand chain, by pushing the load or by electric motor.

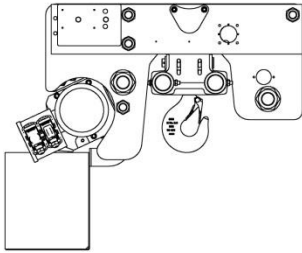

29/06 ER - Table 1 - 1-6, 3t

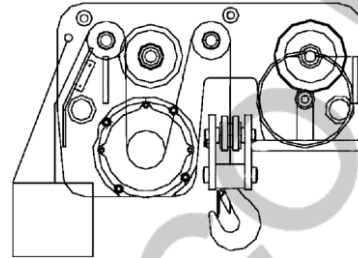

29/06 EH - Table 2 - 8-20 t

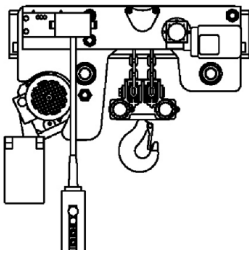

29/06 EE - Table 1 - 1-10 t

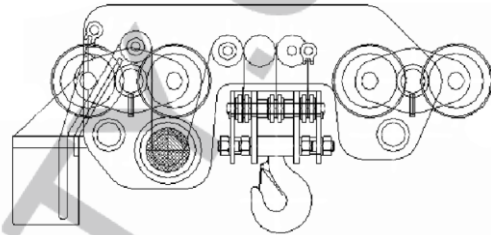

29/06 EE - Table 2 - 2-60 t

4.3 Functions

The lifting gear and motor-driven trolley are moved by pressing the buttons on the control switch. The spring-pressure brake installed in the electric motor of the lifting gear prevents the independent lowering of the load after the push button has been released.

By using a frequency converter, the speed is infinitely variable.

Hand geared trolleys are moved to the left or right by pulling one of the two stands of the endless hand chain.

In combination with push travel trolleys the trolley is moved by pushing or pulling the load or, without load, by pulling the load chain.

NOTICE!

The best protection against functional failures in case of extreme environmental impact is the regular use of the equipment.

If the hoist is not used very often, we recommend to carry out a test run at least once a week and to switch on the motor several times during this test run.

In our experience, this will prevent the brake from sticking.

4.4 Important components

NOTICE!

All hoists are fitted with high-quality lifting gears of the reliable AK series.

4.4.1 Motor

	Type of chain hoist
Electric motor	66/04 AK
	28/06E
	29/06E, 29/06EEL Big Bag, 29/06E-Synchro
	90/09EX, 91/09EX

4.4.2

4.4.3 Gear

Lifting gear with ventilation screw

AK 4-8 Precision Spur Gear

AK9+10 Precision Planetary Gear

Trolley gear

Combination of worm gear and motor

Closed design - ventilation not necessary.

4.4.4 Control

Control switch with emergency stop

Classification of control according to lifting gear sizes

Hubwerk	Kind of control			
	Direct control	low voltage control	Radio control	Frequency control
AK4-7	x	x	x	x
AK8-10	-	x	x	x
Alle Ex	-	x	x	-

4.4.5 Overload protection

Type	Slipping clutch	electric limit switch	mechanical stop by spring assembly*
66/04AK,	AK4-8	AK9+10	AK4-10
28/06E,	AK4-8	AK9+10	AK4-10
29/06E,	AK4-8	AK9+10	AK4-10
29/06E-Syncro	AK4-7	-	AK4-7
29/06EEL Big Bag	AK4-7	-	AK4-7
All Ex	AK4-8	AK9+10	-

*optional



DANGER!

The overload protection serves exclusively to protect against damage to the device due to overloading when moving loads. Its function must not be integrated into the operational work process!

4.4.6 Load chain

acc. to EN 818-7 high quality chain

4.4.7 Load hook

Hook in ball bearing with safety catch.

4.4.8 Chain container

According to hoist type made of coated fabric, plastic or of steel plate.

4.4.9 Rotation direction/ Phase sequence relay

Protection against wrong net connection

(only with low voltage control)

4.4.10 Safety limit switch (lifting/lowering)

automatic stop when the load chain does not run correctly

(only applicable for hoists with tensioning device)

4.4.11 Emergency limit switch (only for AK9 lifting unit)

Automatic switch-off and horn if the load chain does not run smoothly through the unit.

4.4.12 Operation limit switch

operational driving into upper and lower hook position

(optional for direct control)

4.4.13 Special components

only for hoists that are used in area at risk of explosion

4.4.14 Emergency brake release - hoist (option)

Manual emergency brake release for lowering the load in case of power supply failure by means of lever (A).

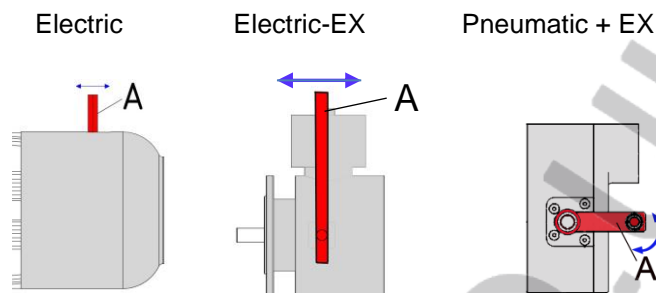

Illustration. 2

4.4.15 Overheat protection electric motor (Only for contactor control)

	Default	Optional	Electro-EX
Lifting/Lowering	PTO	PTC**	PTC**
Ddrive	-	PTO / PTC**	PTC**

thermocouple PTC thermistor with tripping device

4.5 2nd brake (optional)

Additional safety device to hold the load.

Opens in parallel with the main brake. Closes with a slight time delay after the work process.

! CAUTION!
 If there is minimal lowering of the load after the work process, check the main brake and repair if necessary!

5 Technical data

Table 1

Capacity	kg	1000	2000	2500	3200	5000	6300	10000		
Hoisting unit		AK4	AK6	AK7	AK7	AK7	AK7	AK8		
Number of chain falls		2	2	2	2	4	4	4		
FEM 9.511/EN 818-7		2m/M5	2m/M5	2m/M5	2m/M5	2m/M5	1Bm/M3	2m/M5		
Load chain	mm	5x15	7x21	9x27	9x27	9x27	9x27	11,3x31		
Load bar size 1N	mm	74-150	82-156	106-223	106-223	119-215	119-215	119-215		
for beam flange 2N	mm	151-220	157-210	224-310	224-310	216-310	216-310	216-310		
width from - to 3N	mm	221-310	211-306	-	-	-	-	-		
Lifting speed approx.	m/min	4,5/1,1	4/1	5,5/1,3	4/1	2,8/0,7	2/0,5	2/0,5		
Hoist motor output	kW	0,88/0,18	1,8/0,44	4/1,1	4/1,1	4/1,1	4/1,1	4/1,1		
Operating mode S 3	%ED	40/25	40/25	40/25	40/25	40/25	40/25	40/25		
Travel speed approx	m/min	16/4	16/4	16/4	16/4	16/4	16/4	16/4		
Fahrmotorleistung	kW	0,25/0,06	0,25/0,06	0,25/0,06	0,25/0,06	0,42/0,10	0,42/0,10	2x0,42/0,10		
Operating mode S 3	%ED	40/40	40/40	40/40	40/40	40/40	40/40	40/40		
Travel path when reeling off 30 m of hand chain	m	7,8	9,8	6,3	6,3	6,5	6,5	6,5		
Hand chain pull for travel approx	N	90	130	80	100	100	150	180		
Noise emission at 1m distance tolerance +2 dB(A)	dB(A)	65	70	70	70	70	70	70		
max. wheel load approx. at 3 m suspension height	kg	310	640	785	985	1175	1780	2800		
Weight at 3 m track height approx.	kg	128	205	255	255	365	365	710		

SELBY ENGINEERING AND LIFTING SAFETY LTD. TEL: +44 (0) 1977 684 600

Table 2

Capacity	kg	10000	10000	12000	12000	16000	16000	20000	20000	
Hoisting unit		AK9	AK9	AK9	AK9	AK9	AK9	AK9	AK9	
Number of chain falls		2	2	2	2	4	4	4	4	
FEM 9.511/EN 818-7		2m/M5	2m/M5	1Bm/M3	1Bm/M3	2m/M5	2m/M5	2m/M5	2m/M5	
Load chain	mm	16x45	16x45	16x45	16x45	16x45	16x45	16x45	16x45	
Load bar size 1N	mm	155-310	155-310	155-310	155-310	185-310	185-310	185-310	185-310	
Lifting speed approx.	m/min	2,8/0,7	4/1	2,8/0,7	4/1	1,35/0,35	2/0,5	1,35/0,35	2/0,5	
Hoist motor output	kW	5,5/1,4	8,5/2	5,5/1,4	9/2,2	5,5/1,4	8,5/2	5,5/1,4	8,5/2	
Operating mode S 3	%ED	40/25	40/25	40/25	40/25	40/25	40/25	40/25	40/25	
Travel speed approx	m/min	16/4	16/4	16/4	16/4	16/4	16/4	16/4	16/4	
Fahrmotorleistung	kW	0,42/0,10	0,42/0,10	0,42/0,10	0,42/0,10	2x0,55/0,18	2x0,55/0,18	2x0,55/0,18	2x0,55/0,18	
Operating mode S 3	%ED	40/40	40/40	40/40	40/40	40/40	40/40	40/40	40/40	
Travel path when reeling off 30 m of hand chain	m	4,5	4,5	4,5	4,5	4	4	4	4	
Hand chain pull for travel approx	N	150	150	180	180	150	150	220	220	
Noise emission at 1m distance tolerance +2 dB(A)	dB(A)	75	75	75	75	75	75	75	75	
max. wheel load approx. at 3 m suspension height	kg	2900	2900	4550	4550	3600	3600	5650	5650	
Weight at 3 m track height approx.	kg	1065	1065	1665	1665	2380	2380	3250	3250	

Table 2 - continuation

Capacity	kg	25000	25000	30000	30000	40000	40000	50000	50000	
Hoisting unit		AK9	AK9	AK9	AK9	AK9	AK9	AK9	AK9	
Number of chain falls		6	6	6	6	2x4	2x4	2x5	2x5	
FEM 9.511/EN 818-7		2m/M5	2m/M5	2m/M5	2m/M5	2m/M5	2m/M5	2m/M5	2m/M5	
Load chain	mm	16x45	16x45	16x45	16x45	16x45	16x45	16x45	16x45	
Load bar size 1N	mm	185-310	185-310	185-310	185-310	185-310	185-310	185-310	185-310	
Lifting speed approx.	m/min	1/0,2	1,3/0,3	1/0,2	1,3/0,3	1,4/0,3	2/0,5	1,1/0,27	1,6/0,4	
Hoist motor output	kW	5,5/1,4	8,5/2	5,5/1,4	8,5/2	2x5,5/1,4	2x8,5/2	2x5,5/1,4	2x8,5/2	
Operating mode S 3	%ED	40/25	40/25	40/25	40/25	40/25	40/25	40/25	40/25	
Travel speed approx	m/min	16/4	16/4	16/4	16/4	16/4	16/4	16/4	16/4	
Fahrmotorleistung	kW	2x0,75/0,18	2x0,75/0,18	2x0,75/0,18	2x0,75/0,18	2x0,75/0,18	2x0,75/0,18	2x0,75/0,18	2x0,75/0,18	
Operating mode S 3	%ED	40/40	40/40	40/40	40/40	40/40	40/40	40/40	40/40	
Travel path when reeling off 30 m of hand chain	m	4	4	4	4	3,5	3,5	3,5	3,5	
Hand chain pull for travel approx	N	280	280	285	285	290	290	300	300	
Noise emission at 1m distance tolerance +2 dB(A)	dB(A)	75	75	75	75	75	75	75	75	
max. wheel load approx. at 3 m suspension height	kg	3580	3580	4250	4250	5650	5650	6735	6735	
Weight at 3 m track height approx.	kg	2380	2380	2380	2380	3250	3250	3880	3880	

* at the time of going to print this data had not been finalised.

3-phase current motor 400V/50Hz - IP55 – F – max. 1000 m above sea level.

Order-related Special data, refer to the motor nameplate.

6 Installation

The assembly and installation depends on the local environment. The hoist must be suspended in a way that it can position itself freely.

6.1 Trolley

For assembly on a beam a travel limit must be placed at either end of the track.

This must be attached so that any elastic limitation buffer or the trolley wheels are driven against them in their end position when moving.

Generally, additional lifting gear (e.g. fork lift, lifting platforms) will be required for the assembly. These must take the weight of the devices securely.

For hoists up to 6,3t capacity the trolley and the bottom block can be adjusted to different beam flange widths.

Hoists from 8t capacity up are supplied adjusted to a fixed beam flange width in the factory. The adjustment of the bottom block cannot be changed afterwards.



CAUTION!

The distance "X" between the wheel flanges of the trolley wheels must be for trolleys up to 3,2 t: 2-3 mm (1-1,5 mm each side) bigger and

for trolleys from 4 t up: 3-5 mm (1,5-2,5 mm each side) bigger than the flange width "B" of the beam

6.2 Devices with a load capacity of up to 6,3 t

6.2.1 Setting and checking the gauge

The trolley and the bottom block can be adjusted to different beam flange widths.

Setting to the relevant beam flange width "B" is to be made as follows:

- Dimension "X" is set by placing washers (6) from the outer to the inner side ("X" increases) or from the inner to the outer side ("X" decreases).
- Washers must not be put away!
- Tighten the hexagon nut (3) and safety nuts (4) again.
- Flange width "B" and the "X" setting must be checked in all cases.
- The same dimensions as used for changing the track width must also be used for the bottom block (10).
- The load chain (11) must run in parallel vertically. Do not put washers aside from the bottom block.

"B" beam flange width
"X" gauge

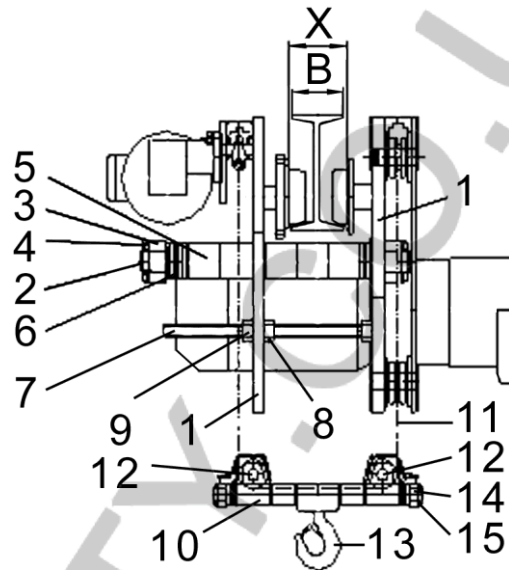

Illustration 3

- Place some washers from the outer side to the inner side and vice versa to adjust the gauge - they must be spread out evenly between the rollers (12) and the hook tackle (13).
- The two-part hook tackle must not be pulled apart.
- Tighten the hexagon nut (14) and safety nuts (15) again.
- Please make sure that the bottom block does not jam at the beam flange when placed in the upper hook position.

- 1 Side plate
- 2 load bars
- 3 hexagon nut
- 4 safety nut
- 5 distance tube
- 6 washers
- 7 threaded rod
- 8 hexagon nut
- 9 hexagon nut

6.2.2 Installation on the beam

- Pre-install the side plates (1) with load bars (2), washers (6), distance tubes (5), hexagon nuts (3) and safety nuts (4) to adjusting value "X" as mentioned above.
- Tighten the hexagon nuts (3) and safety nuts (4) and push the device onto the front face of the beam flange.
- Insert the threaded rod (7) through the corresponding holes and tighten the nuts (8, 9).
- Tighten nut (8) first, then nut (9).

If this is not possible for lack of space or fixed end stops the trolley can also be installed on the beam from below. Please proceed as follows:

- Dismantle the hexagon nut (3) and safety nut (4) at the motor side.
- The trolley halves must be separated until the trolley can be pushed over the track beam flange from below.
- Push the trolley together again until it reaches the correct wheel gauge "X".
- Secure the washers (6) and distance tubes (5) by tightening the hexagon nuts (3) and the safety nuts (4).
- Fasten the threaded rod as mentioned above.

With the devices in table 1 one of 4 wheels is driven by the travel drive. The axis of the driven wheel is set slightly lower to ensure the required wheel pressure for traversing when the device is not under load. To prevent the slack between load bolt (2) and the corresponding holes which are due to the manufacturing process, having a negative impact on wheel pressure, proceed as follows:

- Place a 2 mm thick sheet metal strip each under the 3 wheels which are not driven, loosen nuts (3,4) and (9) slightly and put the device under load at the load hook until the rollers are under pressure.
- Afterwards, tighten all nuts and safety nuts again.

6.3 Devices from 8 t up to 60 t capacity

6.3.1 Installation on the beam

Secure the load bars with set collars (1) and safety screws (3).

- In order to adjust the beam flange width and for installation on the beam, dismantle the safety screws (3) at one trolley side.
- After adjustment of dimension "X" and installation on the beam, install the safety screws (3) again and secure them with nut (4).
- When pulling apart the side plates, the trolley drive shaft will also be moved.
- To do this, loosen the safety screws at the stern tube bearing and secure them again after the side plates have been pushed together.

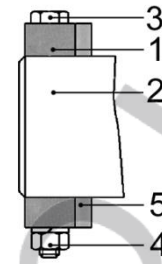

Illustration 4

- 1 set collar
- 2 load bars
- 3 safety screw
- 4 hexagon nut
- 5 washer

6.4 Chain container installation

The chain container is supplied as a complete unit. For the installation of the chain container, the following must be observed:

- Mount chain container (1) with screws (2) in the position provided (3).
- Let the load chain run smoothly into the chain container (1).
- The holding chain (4) which is already fixed to the chain container must be fastened with screw (6) at the position provided therefore at the hoist (5) in such a way that the chain container (1) hangs as horizontally as possible, to achieve this, either shorten the holding chain (4) or another chain link must be added to the holding chain (4).
- Re-check the fastening screws.
- Check whether the load chain of the device can enter the chain container freely by carrying out a functional test without load.

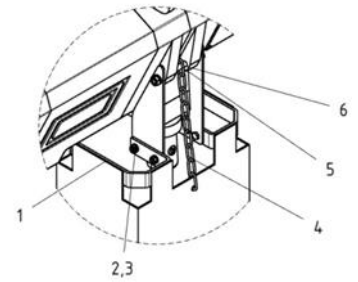
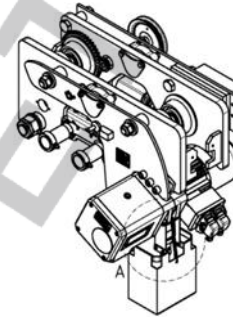

Illustration 5

i The chain container should hang horizontally or as horizontally as possible

- 1 chain container
- 2 screws
- 3 position for screws
- 4 holding chain
- 5 position of holding chain
- 6 screw

6.5 Pedant control installation

The pendant control is supplied with strain relief cable

- 1 Strain relief rope
- 2 Press thimble
- 3 Mounting bracket
- 4 Control cable plug
- 5 Safety clip

- Plug the control cable into the control box and lock.

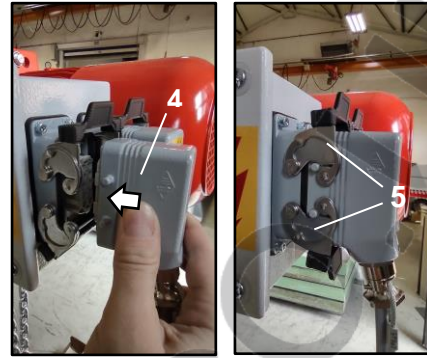

- Put the press thimbles (2) on the lower end of the strain relief cable (1).
- Guide the cable (1) through the fastening bracket (3) of the pendant station.
- loop the rope (1) around the fixing bracket and guide it back through the press thimbles (2).

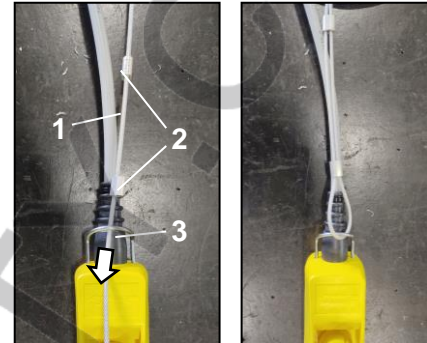

- Set the required height of the pendant station and crimp the press thimbles (2) with blunt pliers.

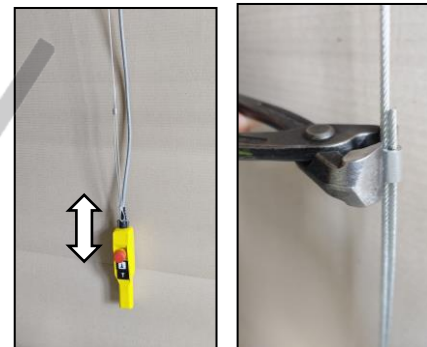

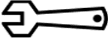
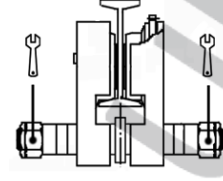
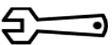
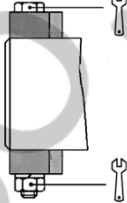
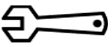

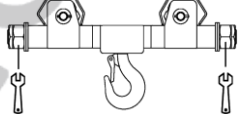
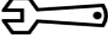

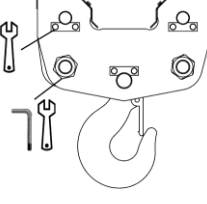

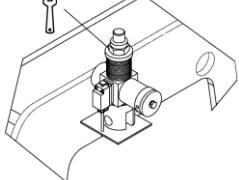

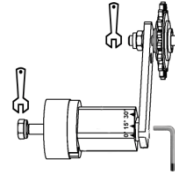





Illustration 6

 **WARNING!**

The height of the pendant control must be selected so that the control cable is never under strain!

6.6 Tools

Capacity	Size	Tool	Use	
1t 1,5t + 2t 2,5t + 3,2t 5t + 6,3t 7,5t + 10t	SW36 SW46 SW55 SW60 SW75		Load bar	
12,5t 16t – 60t	SW22 SW24		Load bar with Fastening ring	
1t 2t 2,5t – 3,2t 5t – 6,3t	SW46 SW55 SW60 SW10	 	Load bar Bottom block	
8t 16t 20t – 50t 16t 8t – 50t	SW36 SW55 SW75 SW6 SW 10	 	Bolt Bottom Block Securing plate	
1t – 50t	SW46		Overload protection	
1t – 50t	SW17 SW8	 	Roller chain Tension device	
	diff.			

7 Control

Only people that are familiar with the operation of the lifting devices and cranes may be entrusted with their operation. They must be authorized by the employer for the operation of the equipment. The employer must ensure that the operating instructions are available near the equipment and that they are accessible for the operating personnel.

Control buttons

Control symbols shown are for optical information only and can vary depending on the control module.

Emergency stop



Illustration 7

Arrow keys = drive left / right



Illustration 8

Arrow keys = Lifting / Lowering



Illustration 9

System start (optional)



Illustration 10

Push button functions (E)

- Relieved push button = stand still
- push button half pushed = slow speed
- push button pushed completely = fast speed



Illustration 11

Red Emergency-Stop button

- button pushed = stand still
- turn the button clockwise = free functions



Illustration 12

NOTICE!
 Lockable Emergency-Stop buttons must first be opened with the key before unlocking!

Emergency release – Hoist (as option)

In order to be able to drain the load in the event of a power supply failure, it is possible to release the brake manually by means of lever (A).

Elektric

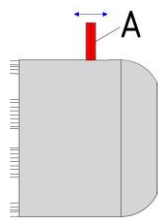

Elektric-EX

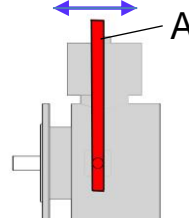

Pneumatic + EX

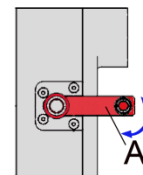

Illustration 13

DANGER!
 The emergency drain may only be used in the event of a power supply failure and not in the event of a technical fault on the unit!

NOTE!
 A minimum weight of approx. 20% of the rated load is necessary for lowering. This value depends on application and ambient conditions!

 **CAUTION!**

Run in of chain into the chain container for hoist with double lifting mechanism

For a correct run in of chain into both chain containers, the lowering operation must be carried out, without load, at certain intervals, until both chain container are empty.

For motorized devices with operating limit switches "lowering"

Lower until the operating limit switch is released.

Non-observance can lead to device damages!

 **CAUTION!**

For motorised units with emergency limit switch (AK9 hoist unit)

After the emergency limit switch has been triggered, it must first be unlocked by a short lifting or lowering process (in the opposite direction to the triggering process). Then check the chain and limit switches for the cause of the fault!

8 Operation

The following, important points must be observed when operating the equipment:

- Read the safety instructions.
- Never load the devices beyond their working load limit.
- When changing the motor turning direction, allow the motor to come to a standstill first.
- The prescribed maintenance intervals must be adhered to.
- Observe the duty cycle, i.e. intermittent operation S3-40% ED (as per VDE 0530) means that in a period of 10 minutes the motor can operate – no matter the height of the load – for 4 minutes. It is therefore irrelevant whether the 4 minutes are continuous (i.e., in case of very high lifting heights) or are made in intervals.
- The lifting tackle or the load must be securely attached to the hook and be seated at the bottom of the hook. The safety catch must always be closed.

 **DANGER!**

In particular, use is not permitted:

- for tearing loose fixed loads, dragging of loads as well as diagonal pulling
- for pulling against a fixed point without additional safety and/or measuring equipment against exceeding the nominal load
- in potentially explosive atmospheres, unless the equipment has been modified for this purpose and this is shown on special type plates it carries for this purpose.
- in reactor containments
- for transporting persons
- for holding lifted loads
- for scenic use
- when persons are under suspended loads

 **NOTICE!**

The overload is set at the factory according to the specifications in the test book. During operation, the nominal load of the unit must not be exceeded!

9 Commissioning

9.1 General

The operator of the unit is responsible for the entire system.

According to the Ordinance on Industrial Safety and Health, a hazard analysis must be carried out by the operator.

Observe the respective national standards, regulations and directives of the responsible bodies at the place of operation.

 **NOTICE!**

Hoists up to 1000 kg capacity and without motor-driven trolleys of hoisting unit must be tested by a "qualified person" before putting into operation for the first time.

Hoists of 1000 kg capacity and up or with more than one motor-driven hoist movement; i.e. lifting and trolley movement, must be tested by a "licensed qualified person" before putting in operation.

An exception is "hoists ready for operation" acc. validated national regulations with EU-declaration of conformity.

Definition "qualified person" (former expert)

A "qualified person" has learned, due to occupational training and experience and the job that the person has done, the skills needed to tests the material for one's work.

Definition "licensed qualified person" (former approved expert)

A "licensed qualified person" has, due through special occupational training, knowledge about testing of the material for one's work and knows the national accident prevention regulations and other prescriptions and technical regulations. This person must test the material for one's work regularly with regard to design and kind of use. The license will be given to qualified person be the approved supervision authorities (ZÜS).

9.2 Power supply

9.2.1 Mains connection

Hoist motor technical data can be found it in the "Technical data" chapter.

The following tables show the assignment of the fuses.

- Select connection cross-sections as per VDE 0100.
- Put sleeves on the ends of the cables.
- Insert the connection cable into the connection plug without strain.
- Secure lines as per VDE 0100.

9.2.2 Control line connection

Pendant with cable and plug-in connection. Plug-in before use.

Any changes of the power supply cable must only be effected by qualified personnel.

9.2.3 Power connection of the brake

The low-maintenance D.C. spring-pressure brakes are connected at the factory according to the wiring diagram.

9.2.4 Wiring diagram

Wiring diagrams are situated in the terminal box or can be requested from HADEF by metioning of serial number.

9.2.5 Assignment recommendation of line cross-sections and fuses

Assignment of line cross-sections and fuses must be done acc. to VDE0100.

For total motor output add all motor output data. The technical data of the motors are found in chapter „Technical Data“ resp.on the motor name plates.

Motor output up to	Fuse Slow-blow	Start up-/ Nominal current	Line cross section (mm ²) for line length L (m)		
			L < 50	50 < L < 100	100 < L < 150
kW	A	I _a / I _n			
1,1	10	3-7- times	1,5	2,5	4
2,2	16		2,5	4	6
4	20				
5,5	35		4	10	
12	50		6		

 **NOTICE!**

The values listed in the table refer to 400V/50 Hz three-phase current and are recommendations.

The exact determination of the supply line must be carried out on site by a specialist.

9.3 Gear

NOTICE!

For transport, some gear types are fitted with a plug screw. Replace the plug screw by a ventilation screw (attached) before putting the unit into operation.

9.4 Load chain

- Before commissioning the load chain must be aligned and oiled.
- Move safety note and fixing wire away from the chain.

9.5 Power operated hoists with chain container:

Due to the transport and / or installation of the hoist on the beam, the position of the load chain in the chain container can change unfavorably.

WARNING!

It is mandatory before the first commissioning:

- that the complete load chain without load with the utmost care from the chain container is driven
- i.e. when lowering, pay special attention to the load chain on the chain container side, so that the load chain can run properly through the hoist without being twisted
- only after the chain container is completely empty, the load chain without load, can be returned to the chain container
- during the running in of the load chain, lubricate it over its entire length



CAUTION!

Do not use grease for lubrication of load chain.

Without lubrication, manufacturer's warranty and/or liability will be void.

NOTICE!

Continuous, thorough lubrication will increase the life of the chain considerably.

10 Safety check

Before putting into service initially or when putting back into service, it must be checked whether:

- All fastening screws (if existent), socket pins, flap socket and safety devices are tightened and secured.
- The oil levels in the gear boxes are sufficient.
- All movements of the load comply with the symbols on the control switch.
- The chains are correctly placed, oiled and in good condition.

11 Functional test

11.1 Checks before the initial start-up

Lifting gear

- Load chains must not be twisted.
- Lubricate the load chain with gear oil or suitable chain lubricant before first loading.

Trolley drive

- The open-lying teeth of the trolley drive must be lubricated.

Hand gear for hand geared trolley

- Ensure correct fit of the hand chain, it must not be twisted and must hang freely.

11.2 Functional test

Lifting gear

Check lifting and lowering functions, initially without a load. The buttons of the control switch are marked with the symbols for lifting and lowering. The movement direction of the load (lifting or lowering) must correspond with the push buttons (lifting or lowering). This is the factory setting.

If the device lowers when the “lift” button is operated and lifts when the “lower” button is operated, the two phases of the net connection must be swapped.

The function of the end switch is to be checked initially by operating the end switch by hand. Then carefully move to the end position. If required, adjust end switch.

Then check the brake function under load. After releasing the buttons of the control switch, the load must be securely held.

Trolleys

Carefully move the trolley to the end positions and check the positions of the end stops.



NOTICE!

The limit switch function will only work if the movement direction of the load (lifting - lowering) corresponds to the push buttons of the control switch.

12 Maintenance

12.1 General

All monitoring, servicing and maintenance operations are to ensure correct functioning of the equipment; they must be effected with utmost care.

- Only “qualified persons” may do this work.
- Servicing and maintenance work must only be done when the hoist is not loaded.
- Records must be kept of all test results and measures taken.

12.2 Monitoring

The monitoring and servicing intervals stated are valid for operation under normal conditions and single-shift operation. In case of severe operating conditions (e.g. frequent operation with full load) or special environmental conditions (e.g., heat, dust, etc.), the intervals must be shortened correspondingly

12.3 Replacing the load chain



CAUTION!

If there is any visible damage and when the conditions for replacement are reached (i.e. one or several dimensions in the table have been reached, there is corrosion or elongation), the chain must be replaced.

When replacing the chain, also check the chain wheels.

Procedure:

- Only insert new chains in an unloaded state.
- Remove chain from its fastening at the end and attach a chain link which is open at the side.
- A chain link which is open at the side, can easily be produced by grinding out a small piece. The opening must have the same thickness as the chain link.
- Hang a new original chain (same size and oiled) in the side opened chain link and insert it.



Illustration 14

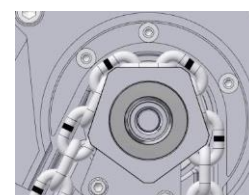

Illustration 15



NOTICE!

The weld seam of the chain must be on the outside.

- Make sure the chain is not installed twisted.
- Make sure the chain links are aligned in one direction.

- Assemble the chain to the end fastening.
- Running of the chain into the chain container:
- Always run chains into the chain container by using the motor.

CAUTION!

Fill in the chain always motor driven.

Never run the chain in by hand, as there is a risk of knotting which can cause malfunctions and damage to the device.

12.4 Brake motor

Brake: 180 V DC

chain hoist	Brake PrB	Brake B	nominal braking moment	Tightening moment screw	Nominal air gap	air gap max.	Rotor strength min.
T/chain falls	Gr.	Gr.	Nm	Nm	mm	mm	mm
1/2	10	--	10	6	0,2	0,8	5,5
2/2	13	--	20	10	0,3	0,8	7,5
2,5/2 to 10/4	15	--	28	10	0,3	0,9	9,5
8/2 to 60/12	--	12	32	9,5	0,3	0,75	8

12.4.1 Assembling the brake

- 1 Insert the retaining ring (1) into the shaft slot.
- 2 Insert the feather key (2) into the motor shaft.
- 3 Fix hub (3) with retaining ring (1).
- 4 Assemble the friction plate (4) if existent.
- 5 Push the rotor (5) onto the hub (3).
- 6 Lock the magnet body with the 3 fastening screws (6).
- 7 Set air gap "a" (refer to "adjusting the air gap")
- 8 Assemble the dust-protection ring (7) if existent.

9 Electric connection

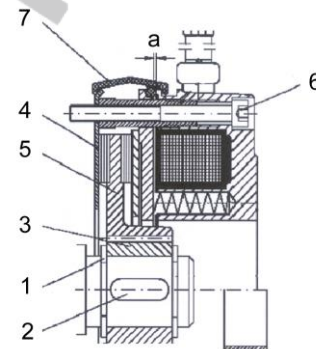

Illustration 16

12.4.2 Disassembly of the brake

Disassembly is performed in reverse order to the assembly.

12.4.3 Adjusting the air gap

View "X" on the brake.

- 1 Loosen the locking screws (6) by half a turn.
- 2 Turn the cap screws (8) into the magnetic body (9) anti-clockwise.
- 3 By turning the locking screws (6) clockwise, move the magnetic body (9) towards the anchor plate (10) using a feeler gauge until nominal air gap "a" is reached (see table).
- 4 Unscrew the cap screws (8) from the magnetic body clockwise.
- 5 Tighten the locking screws (6).
- 6 Check the air gap again and re-adjust if necessary.

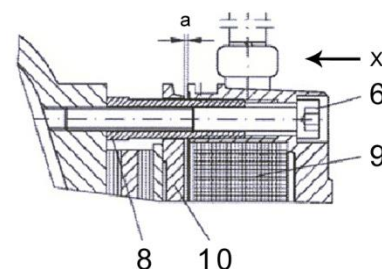

Illustration 17

12.5 Overload protection

If the hoist does not lift the permitted load, the overload protection must be adjusted. Adjustment may only be done by a service company, authorised by the manufacturer!

! DANGER!

The factory setting of the overload protection is secured by a seal. Any guarantee becomes invalid if this setting is changed. Should maintenance be necessary, please contact a service company that is authorised by the manufacturer.

! DANGER!

The overload protection serves exclusively to protect against damage to the device due to overloading when moving loads. Its function must not be integrated into the operational work process!

Depending on the type of hoist, the following variants are possible:

12.5.1 Slipping clutch

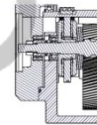

Illustration 18

12.5.2 Mechanical spring assembly

In case of overload the load must be lowered until it reaches the ground so that the spring assembly can release. Only thereafter it is possible to repeat the lifting motion.

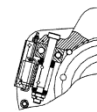

Illustration 19



Illustration 20

12.5.3 Electronic hoisting power limiter (as option, except serial AT)

Power consumption of the hoist motor is measured during lifting movement of a load by an adjustable power measuring device (overload guard). The setting is made via a separate relay for main and creep lifting speed. Power consumption of the motor is load-dependent and increases with the load. If the set value is exceeded, the relay responds and switches the motor off via switching elements. After the overload protection has been activated the LOWER button must be pressed first so that the LIFT function can be activated again. Before lifting again the load must be reduced to the nominal load!



Illustration 21

12.6 Stretch the roller chain.

Only applicable for hoists acc. to table 2

Tension of the roller chain must be checked and adjusted if necessary.



Illustration 22

For correct adjustment there is a mark on the tension device (B).

Procedure:

- Hold tension device (B) with the wrench SW 36.
- Release screw (A) with wrench SW 17.
- Turn tension device (B) until the edge (◀) of the tension lever (C) fits precisely with the ▶ 15° mark (▶◀).
- Tighten screw (A) again.

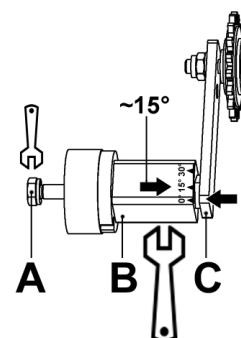

Illustration 23

13 Inspection

13.1 General Overhaul for motor-driven units

The validated, national accident prevention regulations must be observed and the measures to reach "safe working periods (S.W.P.)" according to FEM 9.755.

After the "theoretical working time D" has been elapsed, the owner/user must take motor driven devices out of operation and effect a General Overhaul.

Further use of the equipment is only allowed after a licensed qualified person has proofed

- that further use is possible without doubt

and

- the conditions for further use have been determined

These conditions have to be written down in the test book.

The owner/user is responsible to make sure that these conditions are observed.

13.2 Periodic checks

Independently from the regulations of the individual countries, lifting devices must be checked at least yearly by a qualified person or licensed qualified person regarding its functional safety.

13.2.1 Components to be checked

The following must be checked:

- Dimensions of load chain, load hooks, pawls, bolts, ratchet wheels, brake linings.
The dimensions must be compared to the dimensions in the tables.
- A visual inspection for deformations, cracks and corrosion must be carried out.



CAUTION!

When the wear limit is reached, the part must be exchanged by a new, original part.

13.2.2 Inspection intervals

	at commissioning	daily checks	1st maintenance after 3 months	Inspection and maintenance every 3 months	Inspection and maintenance every 12 months	Inspection and maintenance every 36/60 months
Inspection of the equipment by a qualified person (periodic inspection)					X	
screw connections	X				X	
brake function - brake discs	X	X				
overload protection as slipping clutch (if relevant)	X				X	
overload protection by current cut-off (electric hoist) (if relevant)	X				X	
overload protection by air relieve valve (pneumatic hoist) (if relevant)	X				X	
load chain, clean and oil	X	X*)	X	X		
load chain, elongation and wear				X		
load hook, cracks and deformation					X	
Bearings of chain pulleys, check and lubricate					X	
Hoist gear, oil change						X*)
Trolley wheels, wear					X	
Trolley wheels, lubricate toothed wheels	X*)		X*)	X*)		
*) see chapter "maintenance"						



WARNING!

If one or several of the dimensions fall below or exceed the dimensions in the table, or if cracks or corrosion are found, the parts must be replaced with original spare parts.

13.3 Checking the load chain

CAUTION!

The load chain must be tested over its entire length!

The measure of the load chain must be carried out especially in the areas which are subject to the highest wear. Through the lifting movement, these are the contact points of the chain with sprocket wheel and deflection pulleys.

acc. DIN 685-part 5

L11 = pitch increase over 11 chain links

L1 = pitch increase over 1 chain link

dm = detected link diameter $(d1+d2)/2$

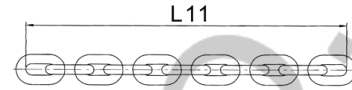

Illustration 24

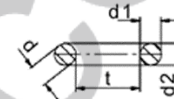

Illustration 25

Chain dimensions

Dimension	Chain dimension					
	5x15	7x21	9x27	11,3x31	16x45	23,5x66
L11	171,4	238,8	300,8	348,1	505,6	743,0
L1	16,0	22,4	28,1	32,7	47,4	69,5
dm	4,6	6,5	8,2	10,2	14,4	21,2

WARNING!

When the dimensions listed in the table are reached due to wear or deformation, the chain must be replaced!

For load chains made of stainless steel, the separately wear dimensions on the "Inspection certificate – Load chain" apply!

13.4 Checking the load hook

Load hook

X = measuring distance hook mouth width

Y = measured length from hook no. 6

H = thickness of hook saddle

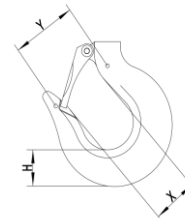

Illustration 26

Hoists according to table 1

Dimension	Capacity in kg/ chain falls				
	1000/2	2000/2	2500/2 3200/2	5000/4 6300/4	10000/4
hook nr.	04	08	1	2,5	4
X	32	38	40	50	56
H	34	37	40	58	67

Hoists according to table 2

Dimension	Capacity in kg/ chain falls				
	10000/2 12000/2	16000/4	20000/4 25000/6	30000/6	40000/2x4 50000/2x5
hook nr.	4	6	8	10	12
X or Y	56	130	145	160	180
H	67	85	95	106	118

Dimensions in the tables are theoretical values without tolerances.

Please fill in the measured values before commissioning:

Capacity	kg
X or Y	mm
H	mm

WARNING!

When the dimension of the hook opening width is deformed by more than 10% or the bottom thickness is worn out by more than 5% due to wear, the hook must be replaced!

For load hooks made of stainless steel, the separate information on the "Inspection certificate – Load hook" applies!

13.5 Inspection – Gear – Oil level

Check oil level all 3 month.

	Locking screw(C)	Tool
AK 4 – AK 6	M10	SW8
AK 7 – AK 8	M12	SW10

Solve the locking screw (C) a bit. (do not remove)
 If oil drips out = level OK.
 Tighten the screw.

If no oil drips out, carry out maintenance and oil change.
 (see chapter maintenance)

AK 9 - 10	Oil gauge glass (C)
-----------	---------------------

Oil gauge glass half full = level OK
 No oil observable = carry out maintenance and oil change.
 (see chapter maintenance)

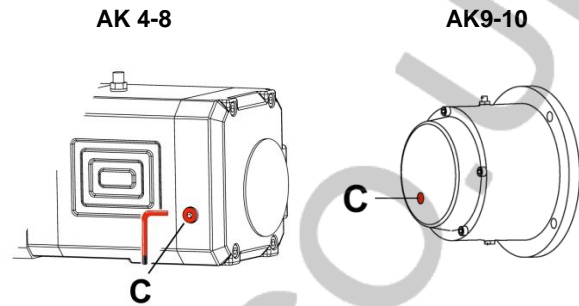



14 Service

14.1 Load chain

Wear at the links is mainly due to insufficient maintenance of the chain.

To ensure optimal lubrication of the links, the chain must be lubricated at regular intervals, depending on usage.



- Lubricate the chain with oil that creeps.
- Always lubricate the chain when it is not under load so that the oil can wet the links affected by wear. It is not sufficient to lubricate the chain from the outside, as this will not ensure the formation of a lubricating film within the links. The adjacent link points must always be lubricated to prevent excessive wear.
- If the same lifting operations are carried out constantly, the switching area from a lifting to a lowering movement must be given special attention.
- Thoroughly effected lubrication of the chain will prolong the life of the chain by approx. 20 times, compared to dry run with unlubricated chain.
- Wash dirty chain with petroleum or a similar cleaner, under no circumstances heat the chain.
- If there are environmental influences that foster wear, such as sand, a dry lubricant should be used, e.g. graphite powder.
- When lubricating the chain's condition of wear should be checked.

Use		Recommendation		Interval
Load chain		oil for example: FUCHS RENOLIN PG 220 or special chain lubricant Use NO grease!	0,2 l	3 month

CAUTION!

Do not use grease for lubrication of load chain.
 Without lubrication, manufacturer's warranty and/or liability will be void.

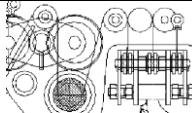

14.2 Pulleys

Use		Recommendation		Interval
Pulleys		FUCHS RENOLIN PG220	Acc. to demand	12 month

14.3 Load hook

- Check bearings and pulleys yearly
- Clean and lubricate the bearings of hooks and pulleys with grease
- Slight bearings are maintenance free

- When bearings resp. slight bearings are worn of, change the complete pulley

Use		Recommendation		Interval
Load hook bearing		FUCHS RENOLIN PG220	Acc. to demand	12 month

14.4 Hoist gear

- Low maintenance.
- Regular lubricant checks required
- Exchange synthetic lubricants after 3 years
- Shorter maintenance intervals for particularly difficult operating conditions, e.g. increased dust and pollution loads or constant operation of the hoist with the highest load
- Lubricant: synthetic, viscosity VG 220

A = Oil fill in or air discharge screw

B = Oil drain plug

C = Oil level glass

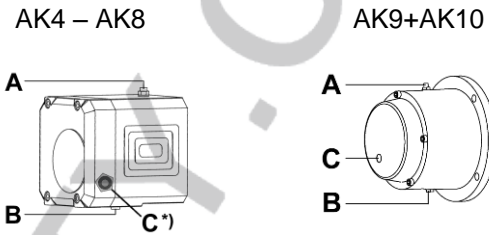

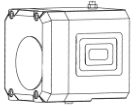
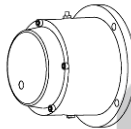
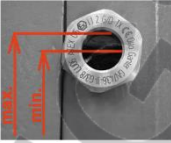



Illustration 27

Use		Recommendation		Interval
Spur gear		FUCHS RENOLIN PG 220	AK/AP4 – 0,45 l AK/AP6 – 1,00 l AK/AP7 – 1,90 l AK/AP8 – 1,90 l	Lubricant change 3 years
Planetary gear		FUCHS RENOLIN PG 220	AK/AP9 = 0,35 l AK/AP10 = 3 l	Lubricant change 3 years
Spur gear *) Planetary gear			Maximum fill level = gauge full filled Minimum fill level = gauge half filled	



*) only by explosion proof electrical equipment

14.5 Trolley

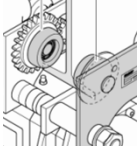
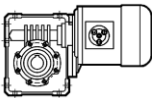
- Trolleys are lifetime lubricated, Refill lubricant is normally not necessary.
- Lubricate gear rim and pinion drive each ¼ year or if required more often, with grease.

Use		Recommendation		Interval
Pulleys Gear rim Drive pinion		FUCHS RENOLIT FEP2	0,1 kg	3 month
Travelling gear If available		SHELL Tivela S320	---	Life time lubrication

14.6 Tension device

Use		Recommendation		Interval
Tension device Roller chain If available		FUCHS RENOLIT FEP2	0,2 kg	3 month

14.7 Electric motor

For the motor it is sufficient to keep the cooling airways clean and monitor the roller bearing and its lubrication status.

A high temperature fat must be used if the roller bearing is replaced.



CAUTION!

Brake linings and surfaces must always be clean and fat-free. Even very small amounts of dirt can reduce the braking moment considerably.

14.8 Lubricant selection

FUCHS	SHELL	ESSO	ARAL	MOBIL	TOTAL	CASTROL	KLÜBER
Renolin PG 220	Omala S4 WE 220	Glycolube 220	Degol GS 220	Glygoyle 30	CARTER SY 220	--	Klübersynth GH 6-220
Renolin PG 320	Omala S4 WE 320	Glygolube 320	Degol GS 320	Glygoyle 320	--	--	Klübersynth GH 6-320
Renolin PG 460	Omala S4 WE 460	Glygolube 460	Degol GS 460	Glygoyle 460	--	Alphasyn PG 460	Klübersynth GH 6-460
Renolit FEP2	Alvaria EP2	Unirex EP2	--	Mobilux EP2	MULTIS EP2	--	--
Renolin B10 VG32	Tellus Oil 32	--	--	--	--	--	--
Stabylan 5006	--	--	--	--	--	Optimol Viscoleb 1500	Klüberoil 4UH 1-1500

Chain lubricant OKS 451

14.9 Lubricant for food industry – selection (as option*)

	MOLYDUVAL	SHELL	MOBIL	CASTROL	KLÜBER
Gear	SYNTHOLUBE A 220 LM	Cassida Fluid GL 220	Glygoyle 220	Optimol GT 220	Klübersynth UH1 6-220
Driving gear	SYNTHOLUBE A 220 LM	Cassida Fluid GL 220	Glygoyle 320	Optimol GT 320	Klübersynth UH1 6-320
Load chain	--	--	Lubricant FM 100	Optimol Viscoleb 1500	--
Load hook Pulley Spur gear Pinion	--	FM Grease HD 2	Mobilegrease FM 222	--	--

* must be mentioned by order

15 Trouble

Please pay attention to the following in case of problems:

- Troubles with the equipment must only be repaired by qualified personnel.
- Secure the unit against unintended operation start.
- Put up a warning note indicating that the unit is not to be used.
- Secure the working area of moving parts of the unit.
- Please read the chapter "Safety instructions".

Notes on the repair of faults are found in the following table.

For the repair of failures please contact our service department.



CAUTION!

Trouble caused by wear or damage to parts such as wire ropes, chains, chain wheels, axes, bearings, brake parts, etc., must be remedied by replacing the parts with original spare parts.

16 Remedy

Problem*	Unit	Cause	Remedy
Unit cannot be switched on	Electric Hoists	No main power	Check connection to mains supply
		Phase sequence not correct (with low voltage control)	exchange 2 phases <i>(see warning note at the plug)</i>
Hoist motor does not run	Electric Hoists	Fuse burnt out	Replace the fuse
		Defective switching unit in the control button switch	Replace the switching unit
		Interruption in the control cable	Check control cable and replace if necessary.
		Defect of capacitor (only for alternating current 1).	Replace the capacitor
		Overheat protection has tripped*	Allow engine to cool
	Defective coil - mechanic or electric overload	Motor must be repaired by a specialist If the unit is suitable for explosive atmosphere, the motor must be returned to the manufacturer for repair!	
	Pneumatic hoists and winches	Operation pressure/ quantity of air is too low	Check connection to mains supply
Hoist motor runs – load is not lifted	For motor driven chain hoists, and winches	After prolonged standstill	See maintenance - pneumatic motor
		Overload protection is activated - (with overload)	Reduce the load to nominal load
		Overload protection is activated - (with =< nominal load)	Check settings and reset if necessary
Hoist motor is running – chain does not lower	For motor driven chain hoists.	No or incorrect power transmission	Let the unit be repaired by an expert For EX-hoists, please clarify with the manufacturer what to do!
		Blockage due to chain link pointing sideways in the feed from the chain container*	Check the chain - lubricate if necessary and/or select a larger chain container so that the chain can be properly arranged before the inlet
Motor hums and uses excessive current	Electric hoists and winches	Defective coil	Motor must be repaired by a specialist If the unit is suitable for explosive atmosphere, the motor must be returned to the manufacturer for repair!
		Rotor is rubbing	See problem "Brake does not release"
		Brake does not release	See problem "Brake does not release"
		Defect of capacitor (only for alternating current 1).	Replace the capacitor
		Defect of starter relay (only for alternating current 1).	Replace the starter relay
Motor does not brake or has excessive afterrunning.	Electric hoists and winches	Phase failure (only direct control)	Find the cause and repair
	For motor driven units.	Switching error after intervention in the electric circuit	Check the electric connection of the brake acc. to the wiring diagram
		Brake linings are worn or dirty.	Brake lining carrier must be changed completely If the unit is suitable for explosive atmosphere, the brake must be returned to the manufacturer for repair!
		Air gap is too large	Re-adjust the air gap If the unit is suitable for explosive atmosphere, the brake must be returned to the manufacturer for repair!
Load drops slightly after the operation	Electrical equipment with 2nd brake	Air gap of main brake too large; brake lining of main brake worn or dirty	Re-adjust air gap, if necessary replace lining carrier If the unit is suitable for explosive atmosphere, the brake must be returned to the manufacturer for repair!
Brake does not release	Electric hoists and winches	Brake rectifier defective	Replace the brake rectifier If the unit is suitable for explosive atmosphere, the brake must be returned to the manufacturer for repair!
		Brake current relay defective	Replace the brake current relay
		Brake coil is defective	Replace the brake coil If the unit is suitable for explosive atmosphere, the brake must be returned to the manufacturer for repair!
		Permissible air gap is exceeded due to worn out brake lining	Re-adjust the air gap and exchange the brake lining if necessary If the unit is suitable for explosive atmosphere, the brake must be returned to the manufacturer for repair!
	Pneumatic hoists and winches	Power drop in the mains power line > 10%	Provide correct power supply voltage
Fuses burnt out or motor contactor is triggered	Electric hoists and winches	Operation pressure/ quantity of air is too low	Check connection to mains supply
		Short circuit in component	Eliminate the short circuit
		Motor has a short circuit in the body or windings	Correct the problem by a specialist For EX-hoists, please clarify with the manufacturer what to do!
Unit stops and honks	Motorised units with AK9 hoist unit	Motor is switched incorrectly	Correct the switching
		Wrong type of fuse	Replace the fuse with correct one <i>(see table "fuses")</i>
		Chain cannot run through the unit without error	Check / align / clean and lubricate chain if necessary
		Operating limit switch is stuck / defective	Clean operating limit switch and repair if necessary.

*) as far as applicable

17 Decommissioning

WARNING!

It is essential that the following points are observed in order to prevent damage to the equipment or critical injury when the device is being decommissioned:

It is mandatory that all steps for decommissioning the machine are carried out in the indicated sequence:

- First secure the working area for decommissioning, leaving plenty of space.
- Read the chapter "Safety instructions".
- Disassembly is carried out in reverse order to the assembly.
- Please make sure that all operating material is disposed of in accordance with environmental regulations.

17.1 Temporary decommissioning

- Measures are as above.
- Also read the chapter "Transport and storage".

17.2 Final decommissioning/disposal

- Measures are as above.
- After disassembly, ensure that the disposal of the equipment and any materials it contains is carried out in accordance with environmental regulations.

18 Additional documents

18.1 Electric wiring diagrams

Electric wiring diagrams are attached to the consignment or included in the terminal box.
Except for units supplied without control.

18.2 Radio control (as option)

Should the unit be fitted with radio control, a manual for radio control is attached to the consignment.